

# Blix



**MOTORISED  
GEARBOX**



**QUICK  
CONSTRUCTION**



**GEAR  
SYSTEM**



**2 WAY  
SWITCH**



**EXPERIMENTS  
WITH WORKING  
MODELS!**

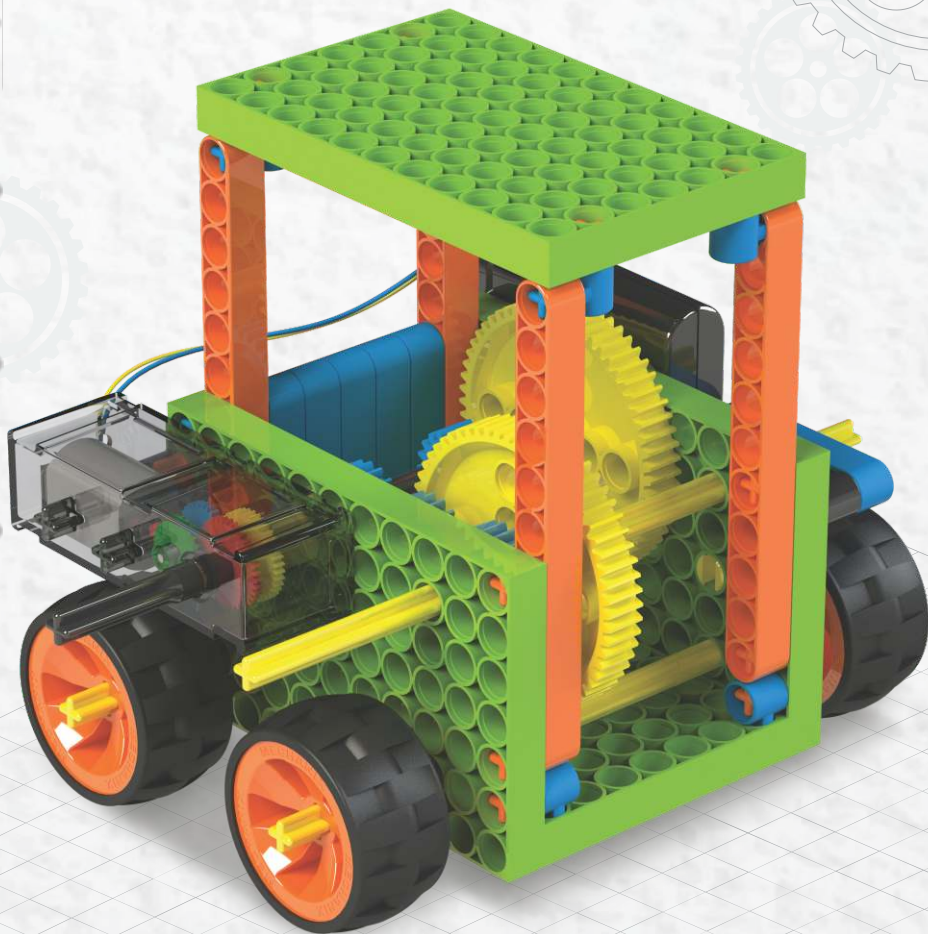

**10**  
EXPERIMENTS

AGE  
**7-99**

**100+**  
PIECES

## DO-IT YOURSELF MANUAL

- 1 Read all instructions carefully before constructing.
- 2 Place all the pieces used in a step on the side before starting.
- 3 Always remove batteries when not in use.

## ○ How to construct

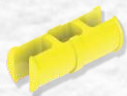

I - CL2 - Use this connector to loosely connect 2 pieces.

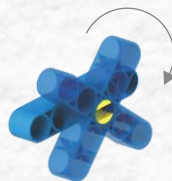
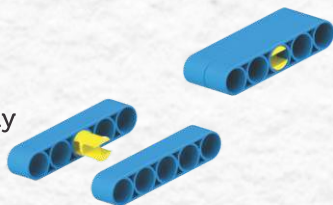

II - CT2 - Use this connector to attach 2 pieces.

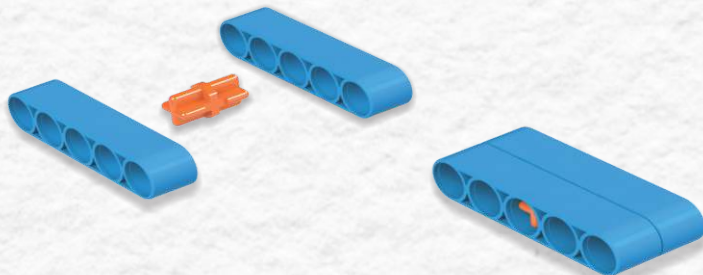

III - CT3 - Use this connector to attach 3 pieces.

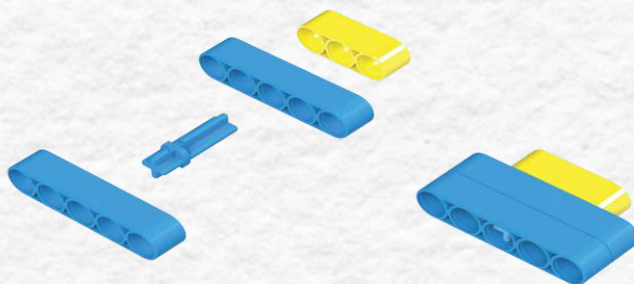

During assembly ensure position of collar is same as in the image in manual.

## ○ How to dismantle

- Narrow edge to remove connectors
- Fit the tool into narrow side of connector collar



- Broad edge to split two pieces

### Precautions:

1. Keep the switch 'Off' when not in use.
2. Make sure the batteries inserted are in the correct position.

## GEARS!

Reminds you of the gear stick near the driver in a car, doesn't it? Well why is that stick there? Have you noticed when it is used? Do you feel more speed when the gear goes up? And do you hear the engine growl when you don't change the gear in time? So why put such a clunky noisy device in a car!

Gears are all around us in most machines that we use daily like cars, watches, toys, printers etc. And they are a fascinating and integral part of our world today. As you go along and finish the 10 experiments in this set, you will understand the working of the gears and their applications in detail.

### First let's start with a few basic concepts:

- 1. Driver Shaft/Input shaft:** The driver shaft is the shaft that is connected to the motor, since the motor is driving all our experiments. There will only be one driver shaft in all experiments.
- 2. Driven Shaft:** The driven shaft is the one that is rotating due to gears meshing with the gears attached with the driver shaft.
- 3. Output shaft:** This is generally also a driven shaft but this shaft usually has the output. For ex. in the form of the rotating wheels.

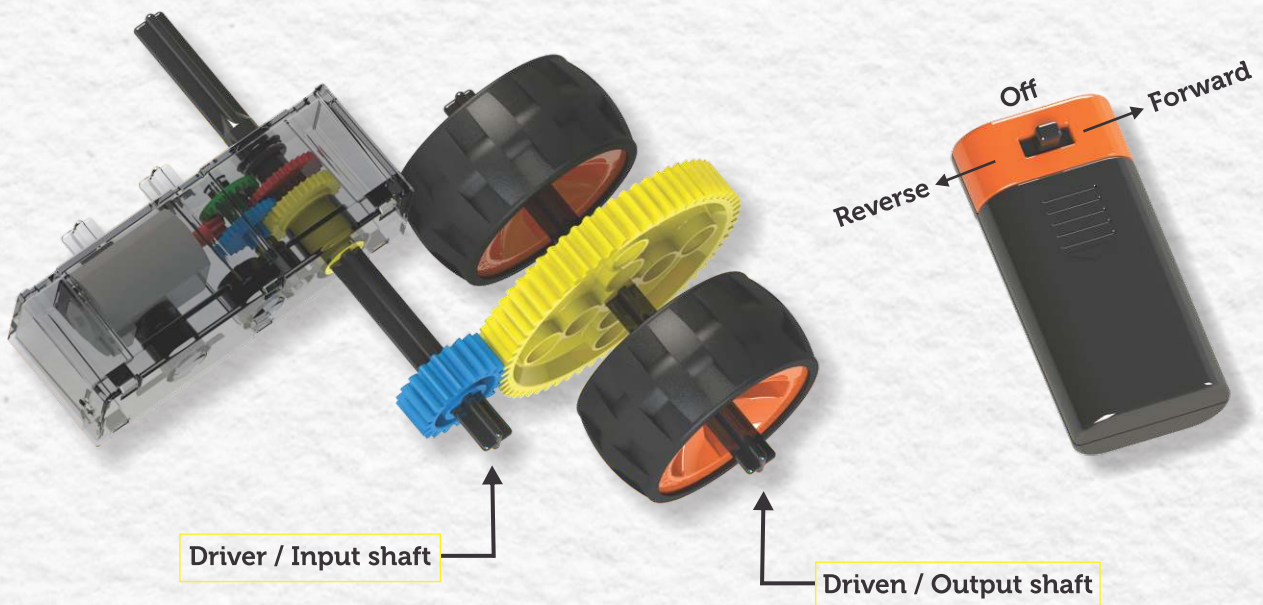

- 4. Battery box:** Battery box is that which gives power to run the motor. The central position is "OFF" position. By sliding the small black button provided on it towards right motor will turn clockwise and sliding towards left motor will turn anticlockwise.

So let's start with our first experiment! Put on your thinking cap and dive into the world of gears with BLIX.

## Experiment 1: Give me power!

In this experiment we are going to mesh 2 gears. We will connect the motor to the small gear (on the driver shaft) and mesh it with the big gear (on the driven shaft).

Follow the instructions below and make the model for experiment 1.

### Step 1

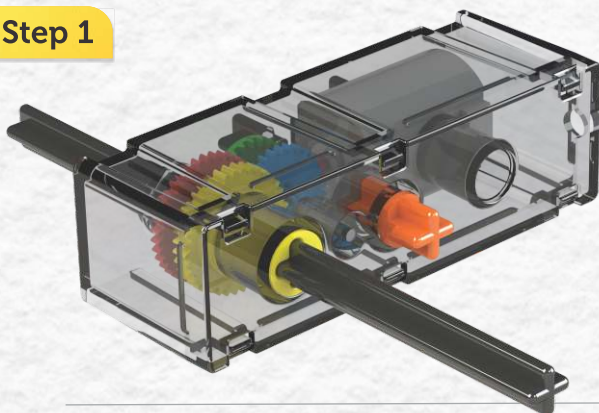

Motor with  
Battery Box



CT2 1 pc.



SH60 1 pc.

### Step 2



TW1 3 pcs.



P7X11 1 pc.



CT3 3 pcs.

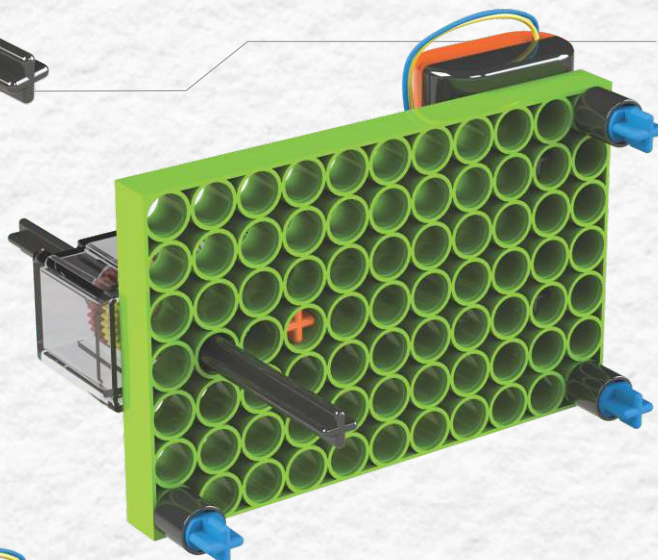

### Step 3

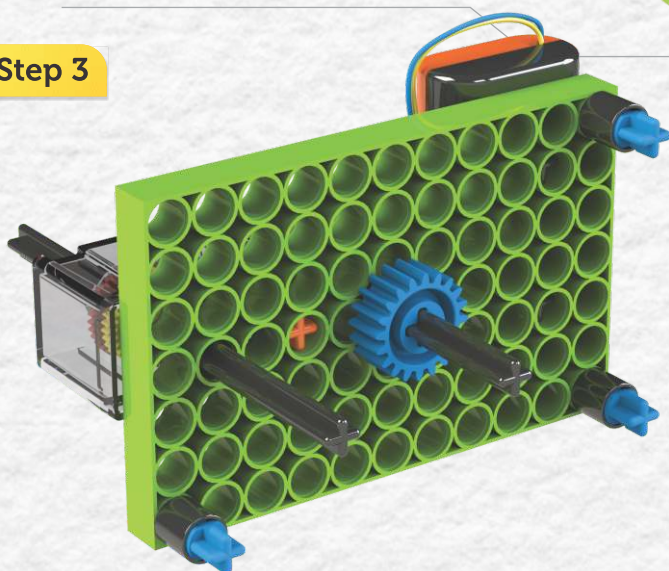

SH60 1 pc.



G(20) 1 pc.

## Step 4

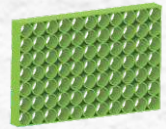
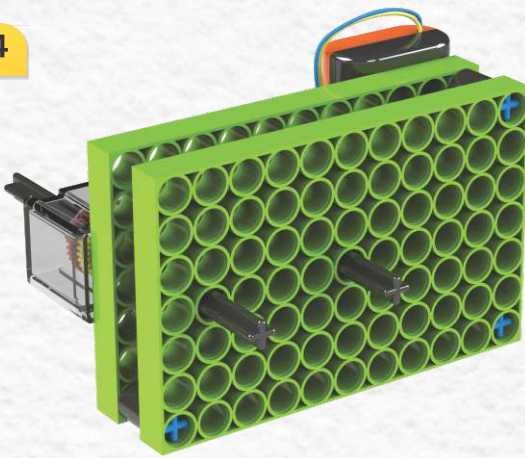

P7X11 1 pc.

## Step 5

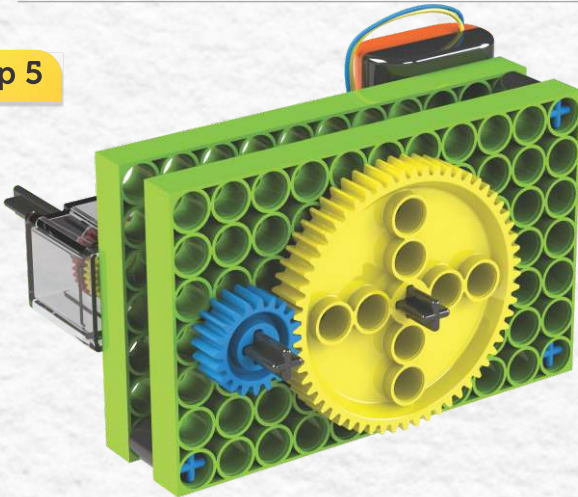

G(60) 1 pc.



G(20) 1 pc.

## Procedure:

- Now switch on the motor and hold the driver shaft with your hands until the motor stops.
- Now hold the driven shaft until the motor stops. What did you notice? Was it more difficult to stop?

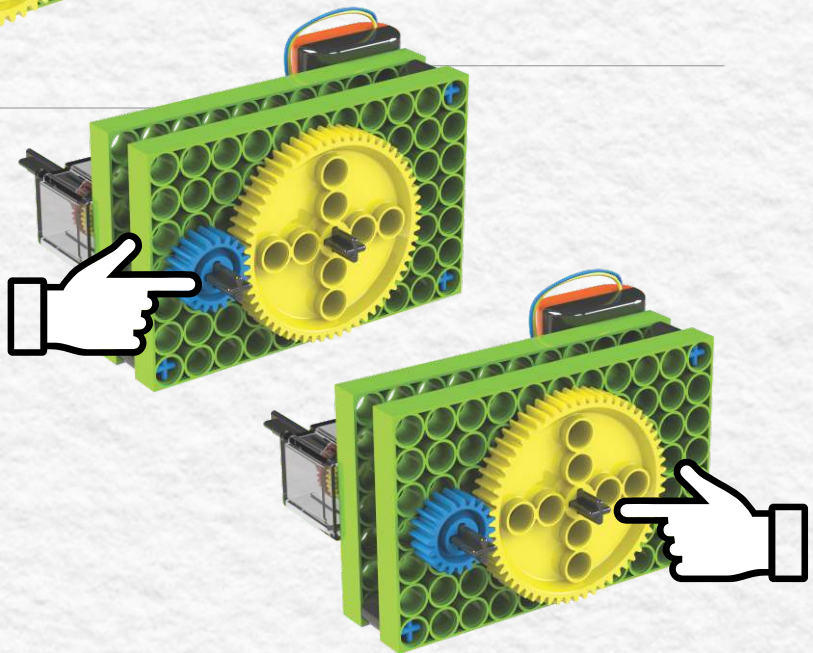

## Theory:

- This turning power is called torque and this is one reason why gears are awesome! You can use gears to increase and decrease power!
- This is why in a car, while going up a slope sometime you have to shift to first gear because power is higher.
- But you must note this increase in torque is at the expense of speed, which reduces.

## Experiment 2: Make me slow!

In this experiment, we are going to use the same model from experiment 1.

### Procedure:

Attach a wheel to the output shaft. Now take a timer and measure the number of times the big gear rotates in one minute. This number is called 'Rotations per Minute' or 'RPM'. Stick a sticker on one side of the wheel to make the counting easier.

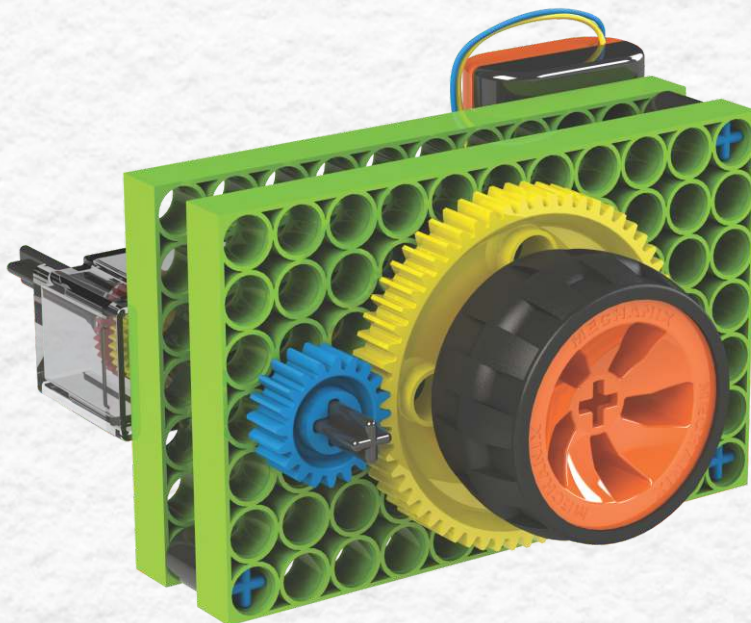

### Calculations:

$$\frac{\text{Teeth on big gear}}{\text{Teeth on small gear}} = \frac{\text{Speed of small gear}}{\text{Speed of big gear}}$$

$$\text{Therefore: } \frac{60}{20} = \frac{\text{Speed of small gear}}{\text{Speed of big gear}}$$

**Therefore:** Speed of small gear = Speed of Motor = 3 X Speed of big gear

$$\text{Speed of big gear} = \frac{1}{3} \text{ X speed of Motor}$$

### Observations:

The gears have reduced the speed of the motor by three times. Now try measuring the speed of the small gear (which would be the speed of the motor), and see if your calculation is same as your observation.

This kind of gearbox is called a reduction gearbox, since it reduces speed. Although as you must have noticed, when the speed reduced, the power increased and since the speed reduced by 3 times, the power has increased by 3 times!

So now we know that 1st gear in a car has the lowest speed and the highest torque!

### Experiment 3: Make me weak

In this experiment we use the same model as in experiment 1 but this time, we will connect the big gear to the motor and the small gear besides it. Lets see what happens!

#### Procedure:

Make the same model from experiment 1, but interchange the positions of the 2 gears.

Hold the driver shaft till the motor stops.

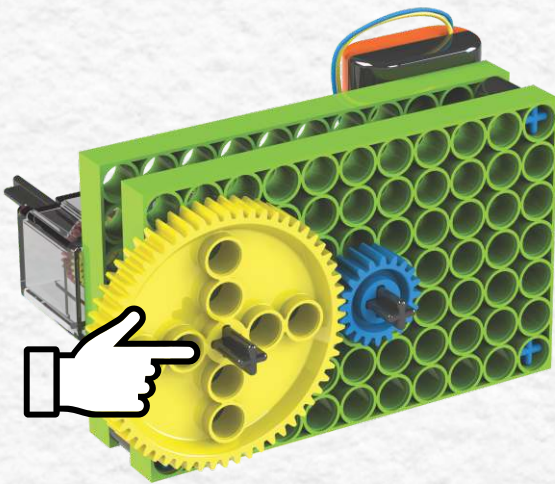

Hold the driven shaft till the motor stops.

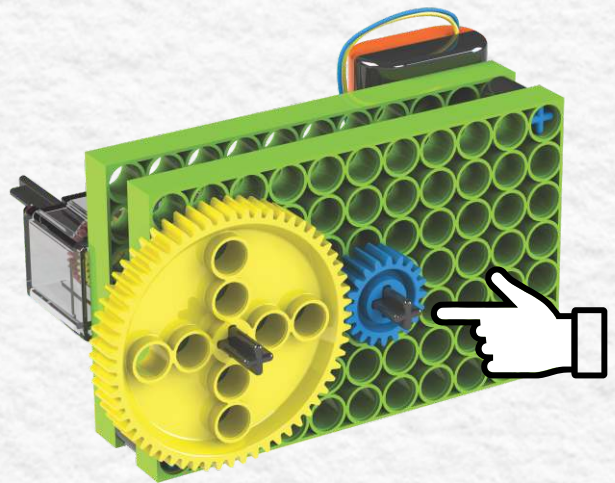

#### Observations:

- Did you notice how the driven shaft has lower power?

#### Theory:

Like in experiment 2, changing speed affects the torque (power). But here since the speed has increased 3 times, the torque has reduced by 3 times.

This is why in the top gear, pick up of the car is very low. But it can maintain high speeds without increasing speed of the engine.

So this is why the top gear in a car has the highest speed and the lowest torque.

## Experiment 4: Give me speed!

In this experiment, we are going to use the same model from experiment 3.

### Procedure:

Attach a wheel to the output shaft.

Now take a timer and measure the number of times the small gear rotates in one minute.

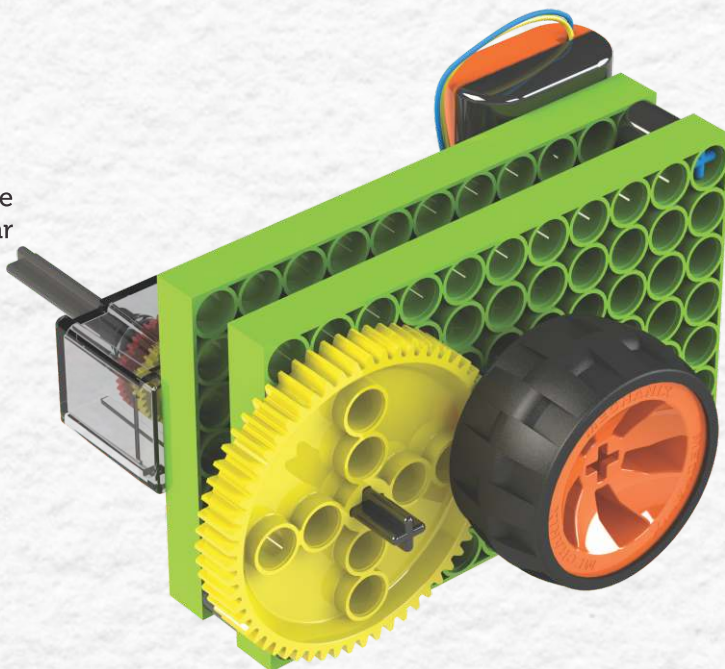

### Equation:

$$\frac{\text{Teeth on big gear}}{\text{Teeth on small gear}} = \frac{\text{Speed of small gear}}{\text{Speed of big gear}}$$

$$\text{Therefore: } \frac{60}{20} = \frac{\text{Speed of small gear}}{\text{Speed of big gear}}$$

Therefore: Speed of big gear = speed of motor =  $\frac{1}{3}$  X speed of small gear  
 speed of small gear = 3X speed of motor

### Observations:

- The gears have increased the speed of the motor by three times. Now try measuring the speed of the big gear (which would be the speed of the motor), and see if your calculation is same as your observation.
- This kind of gearbox is called speed multiplier gearbox, since it increases speed.



## Experiment 5: Changing direction!

Apart from changing speed and power, gears can also change direction of rotation! Let us see this work and make the model for experiment-5.

Follow the steps and make the model for experiment 5.

### Step 1

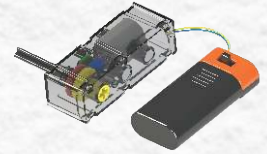
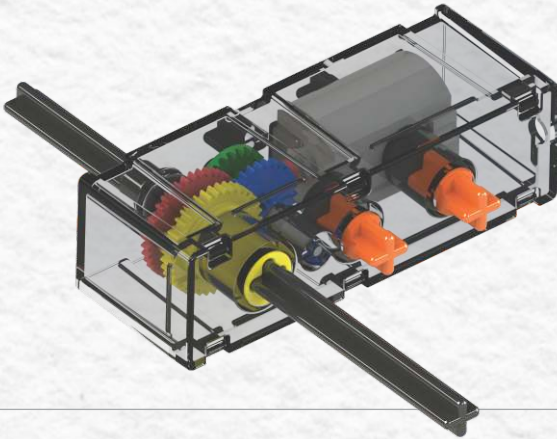

Motor with  
Battery Box



SH60 1 pc.



CT2 2 pcs.

### Step 2

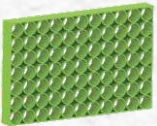

P7X11 1 pc.

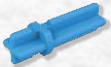

CT3 3 pcs.



TW1 3 pcs.

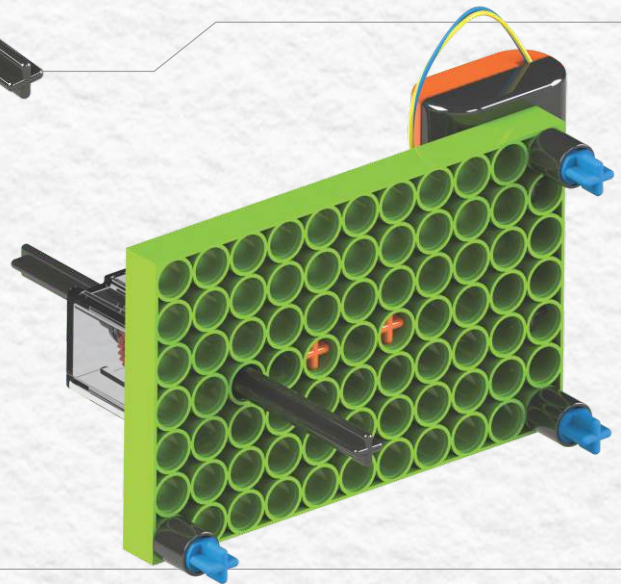

### Step 3

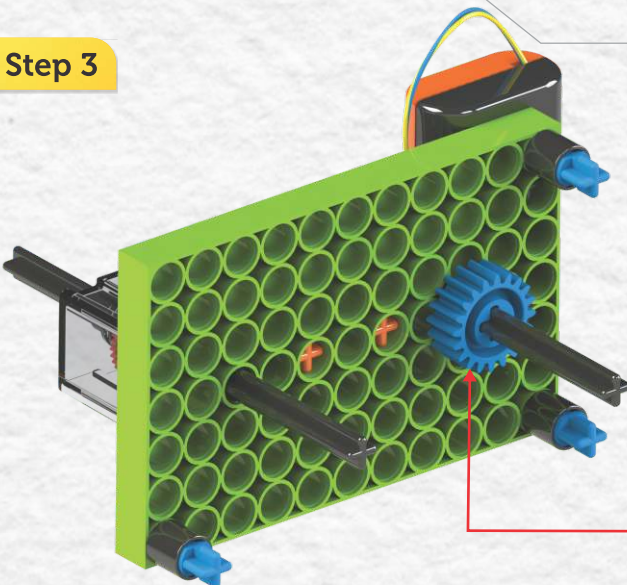

SH60 1 pc.



G(20) 1 pc.

This gear is only used to keep the shaft in place.

## Step 4

# Blix

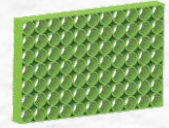
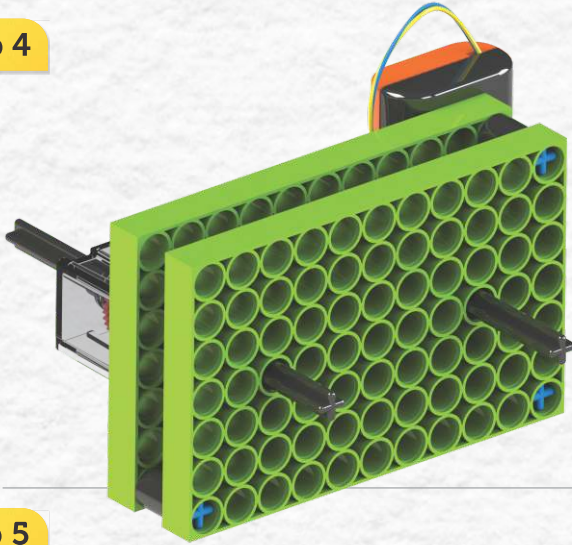

P7X11 1 pc.

## Step 5



G(60) 2 pcs.

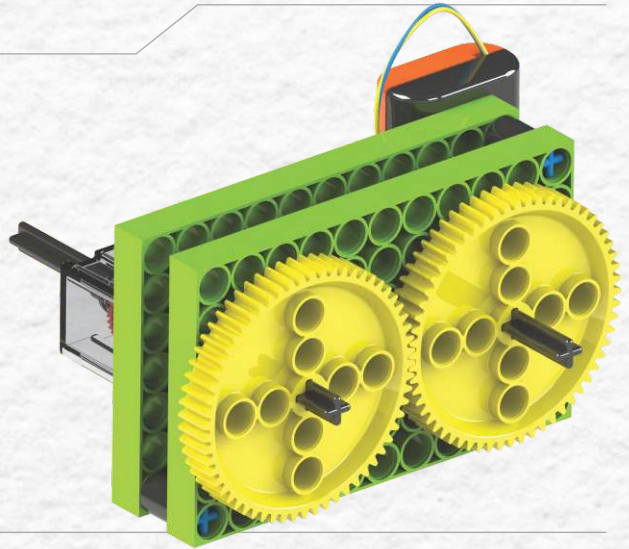

## Step 6

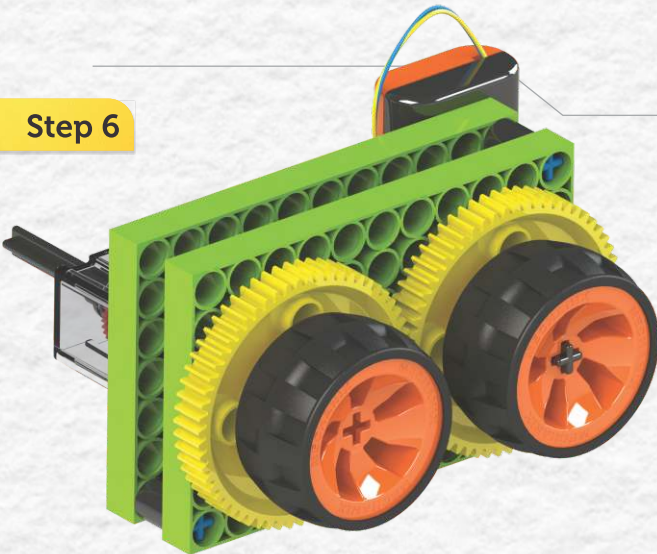

Wheels 2 pcs.

## Observations:

- Did you observe the motion of the 2 gears?
- While one is moving clock wise, the other moves anticlockwise.
- So any two gears meshing with each other always rotate in opposite directions.

## Experiment 6: Idler Gear!

In the last experiment you observed how the gears change direction. But what if you do not want the gears to change direction! There is a trick to help us here as well.

Follow the instructions and build the model for experiment 6.

### Step 1

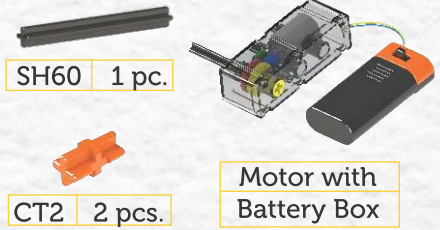
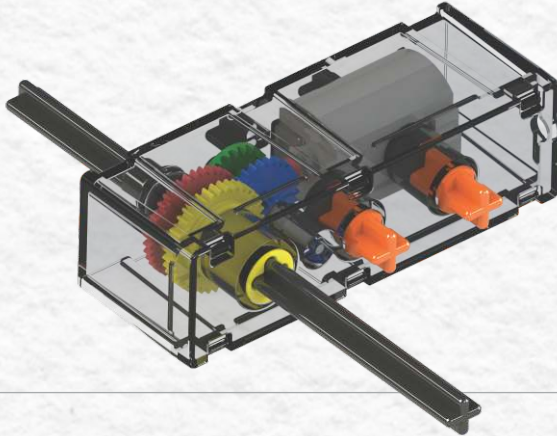

### Step 2

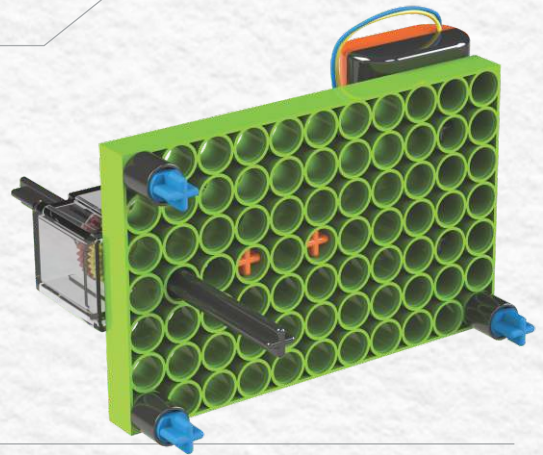
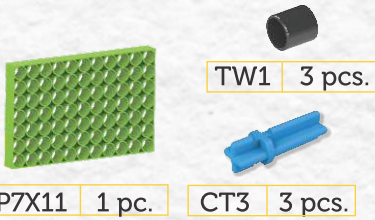

### Step 3

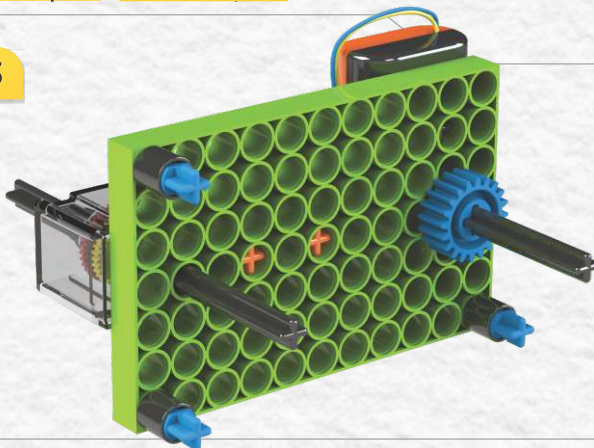

### Step 4

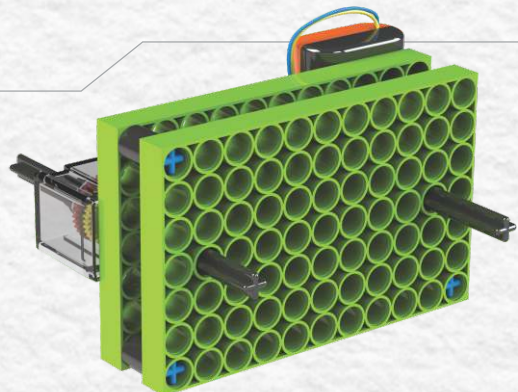
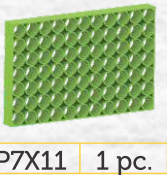

## Step 5

# Blix

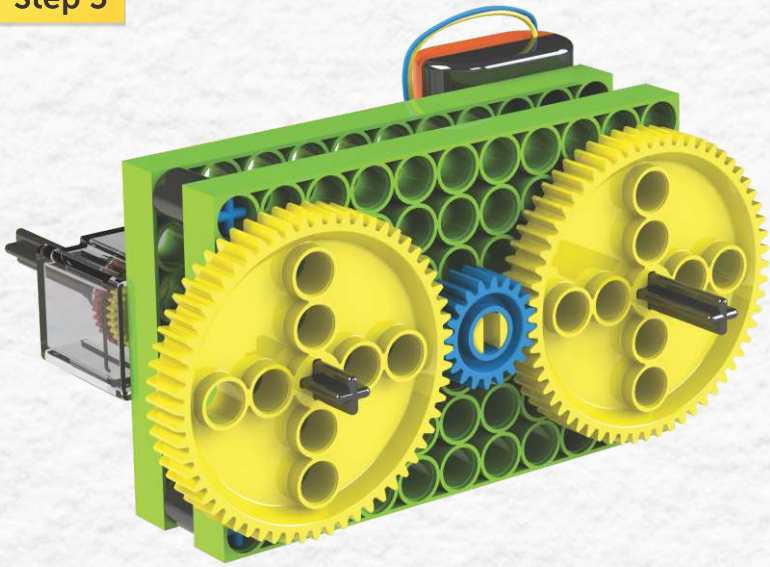

G(60) 2 pcs.

G(20) Idler 1 pc.

CL2 1 pc.

## Step 6



Wheels 2 pcs.

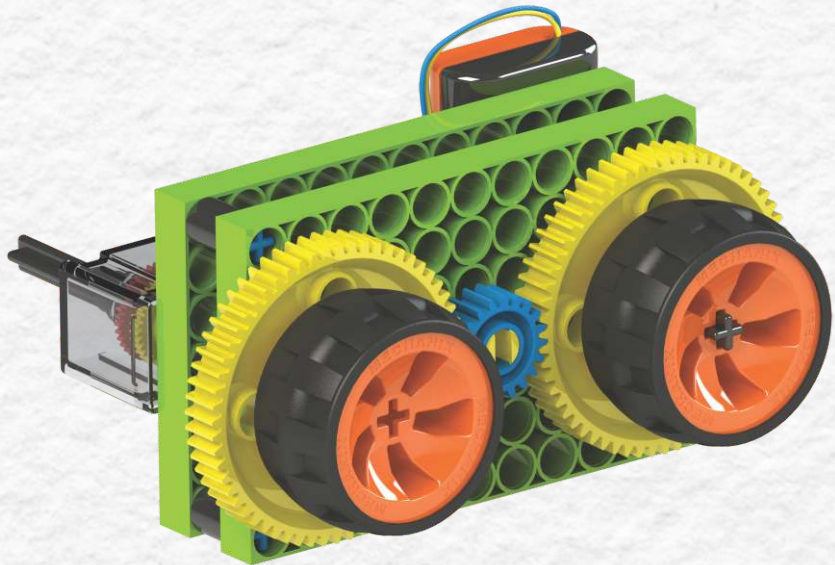

## Observations:

Here you notice how the small gear in the middle is helping to correct the direction of rotation. Now both the gears are rotating in the same direction.

The other thing you can notice about the idler gear is that it is of different size but it doesn't help change the speed or power at all. This is true for how many ever gears you put in between the driver gear and driven gear. Only the difference in size of driver gear and output gear will affect the speed and power, not of all the gears in the middle.

But does this mean that gears are limited to how much reduction or speed multiplication can be done? Well not at all! Check out the next experiment to see how to can change speed or power drastically with only 2 types of gears.

It's important to notice that when you have an odd number of gears in a line, the direction will remain the same and if you have even number of gears in a line, the direction changes.

## Experiment 7: Compound gearbox! (Speed Reduction)

Gears in the middle do not change the speed, but it is possible to create even slower or much faster speeds with the same gears! Using the magical concept of compound gears! In this experiment we will see how to change speed or power drastically in a small gearbox.

Follow the instructions and build the model for experiment 7.

### Step 1

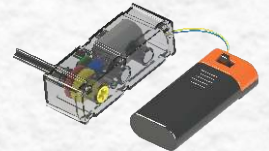
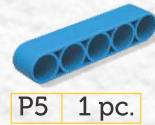
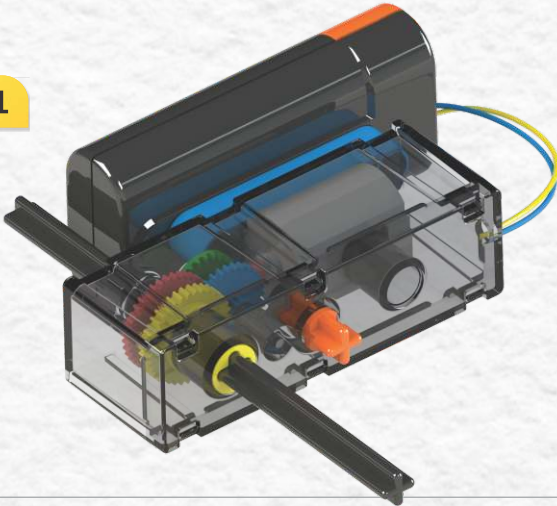

Motor with  
Battery Box



### Step 2

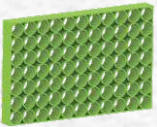

P7X11 1 pc.

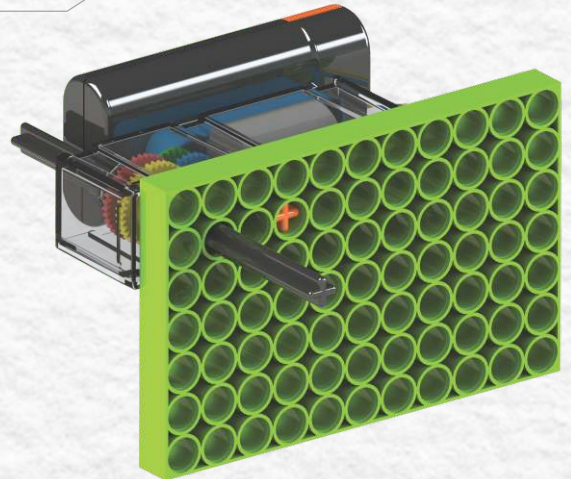
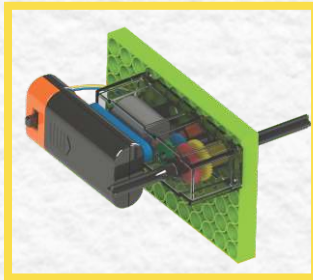

### Step 3

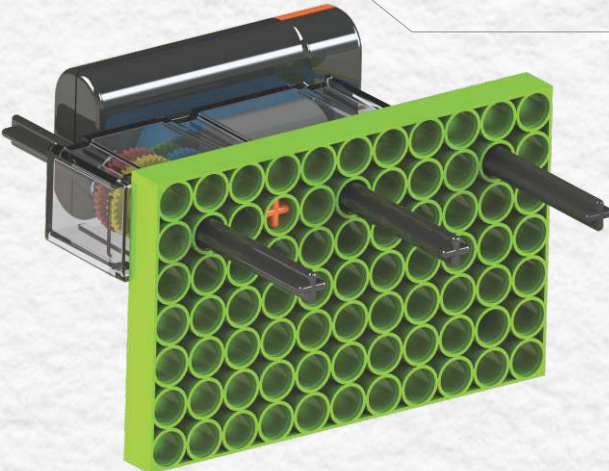

## Step 4

# Blix

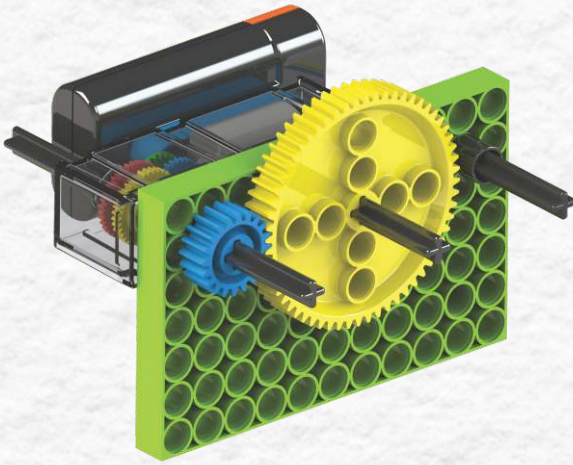

G(60) 1 pc.



G(20) 1 pc.



TW1 1 pc.



## Step 5

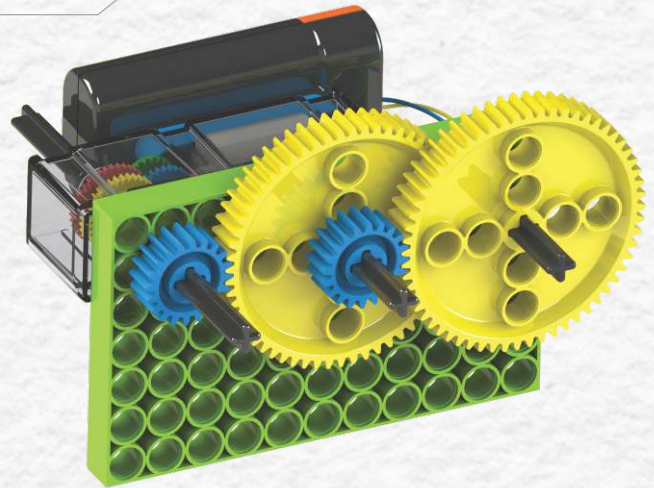

G(60) 1 pc.



G(20) 1 pc.



## Step 6

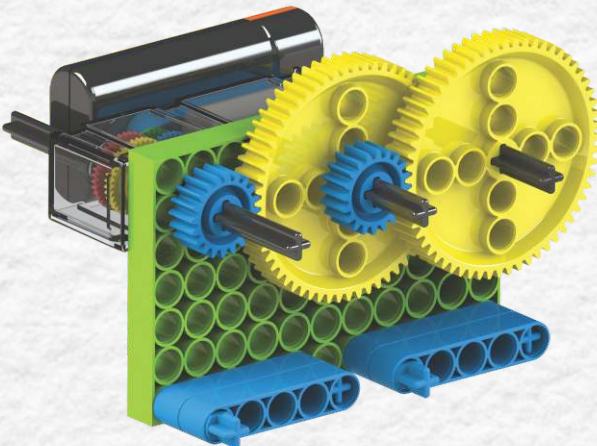

CT3 4 pcs.

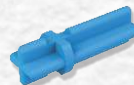

P5 4 pcs.

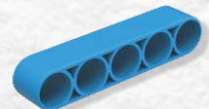

## Step 7

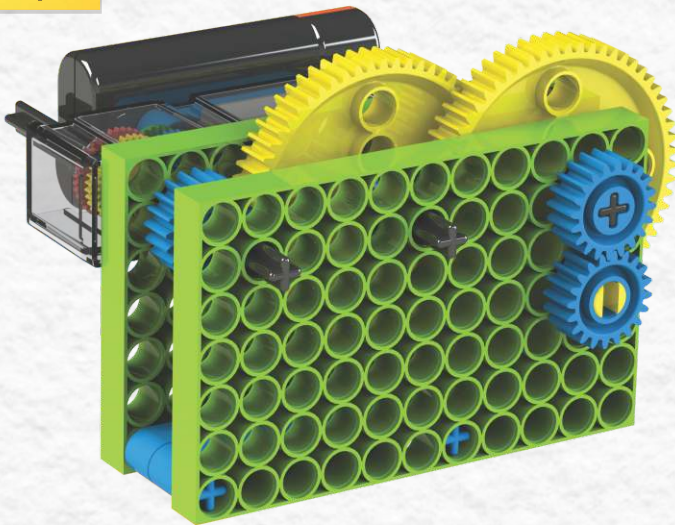

CL2 1 pc.

G(20) 1 pc.

P7X11 1 pc.

G(20) Idler 1 pc.

## Step 8

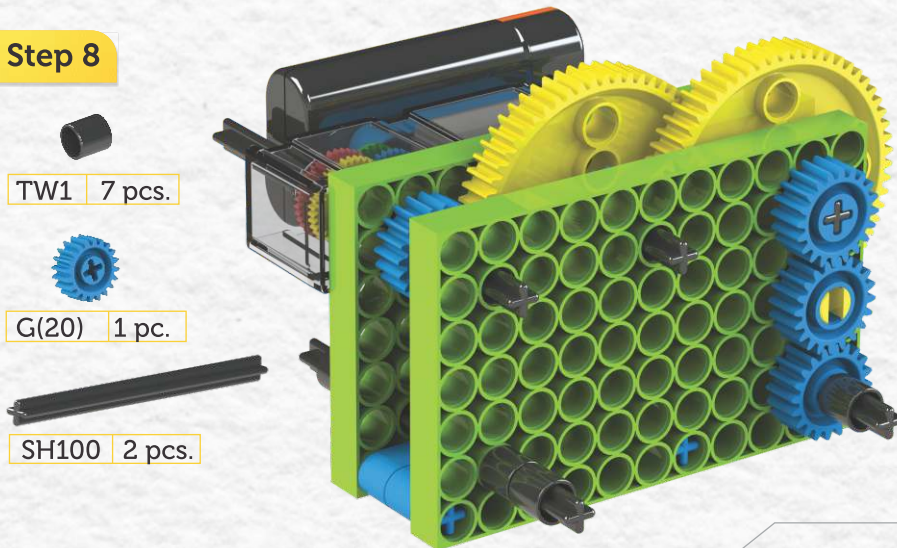

TW1 7 pcs.

G(20) 1 pc.

SH100 2 pcs.

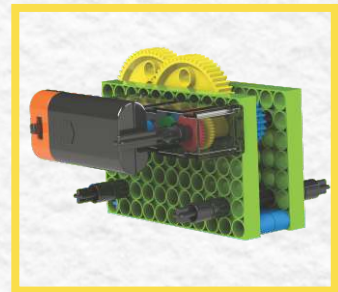

## Step 9

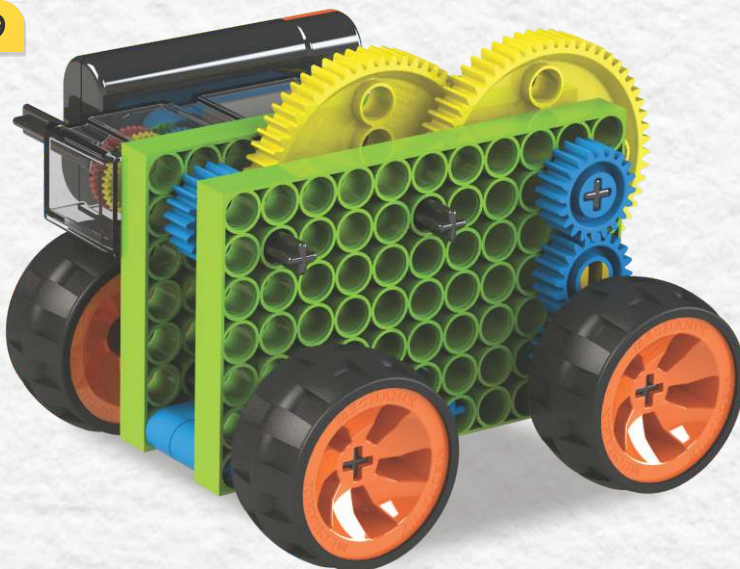

Wheels 4 pcs.

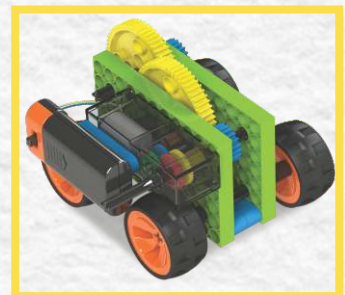

## Equation:

As shown in figure,

If small gear with speed = 60 R.P.M. on first shaft/ driver shaft drives the other big gear on second shaft then speed is decreased by  $\frac{60}{3} = 20$  R.P.M.  
(since the speed is reduced, power is increased by 3 times).

Again small gear on second shaft (driven shaft) rotates another big one which again reduces the speed by  $\frac{20}{3} = 6.7$  R.P.M.  
(since the speed is reduced by  $3 \times 3 = 9$  times, torque is increased by 9 times).

Speed of output gear = 6.7 R.P.M.

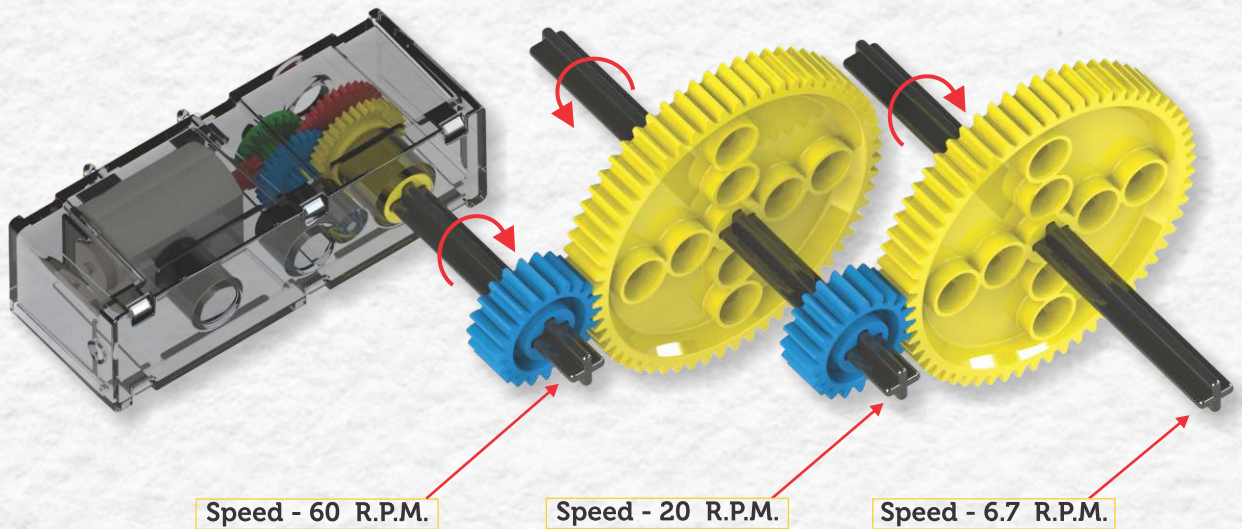

## Observations:

- Now hold the output shaft with your hand until it stops and also hold the input shaft.
- Do you feel the power in output shaft? how much? Yes! Its 9 times more than input shaft.
- Compound gears are basically two different sized gears joint together on a single shaft.



## Experiment 8: Compound Gearbox (Speed Multiplier)

In the last experiment we saw how compound gears can reduce speeds and increase power drastically. But can you imagine how much speed compound gears can increase! Let's find out.

Follow the steps and complete the model for experiment 8.

### Step 1

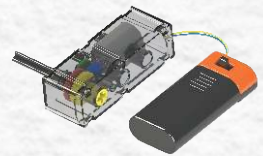
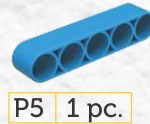
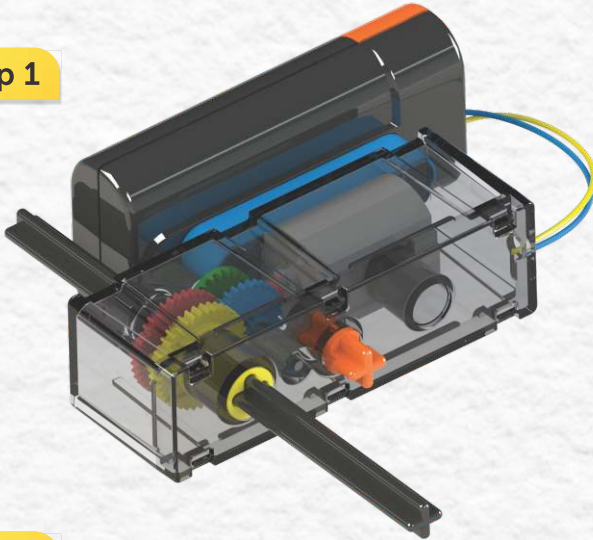

Motor with  
Battery Box

### Step 2

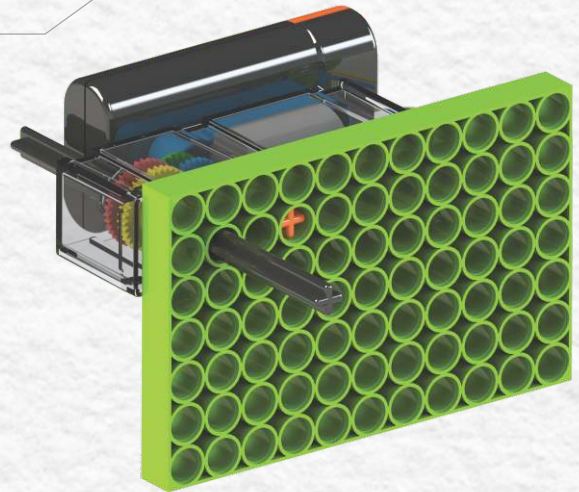
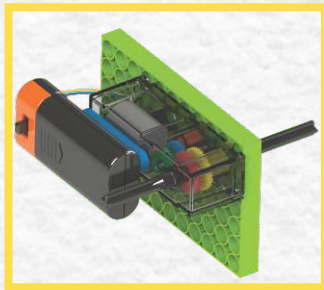
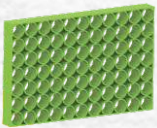

### Step 3

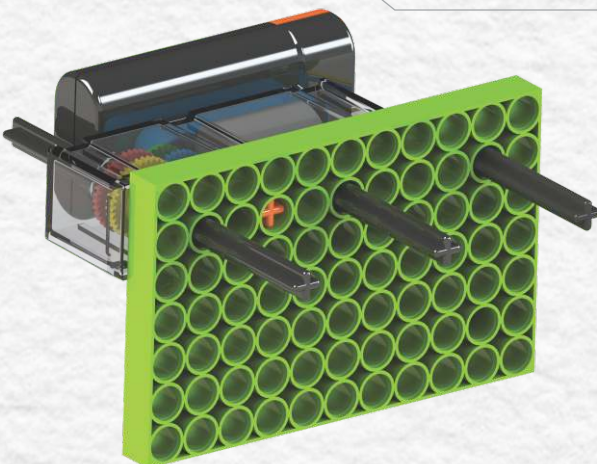

## Step 4

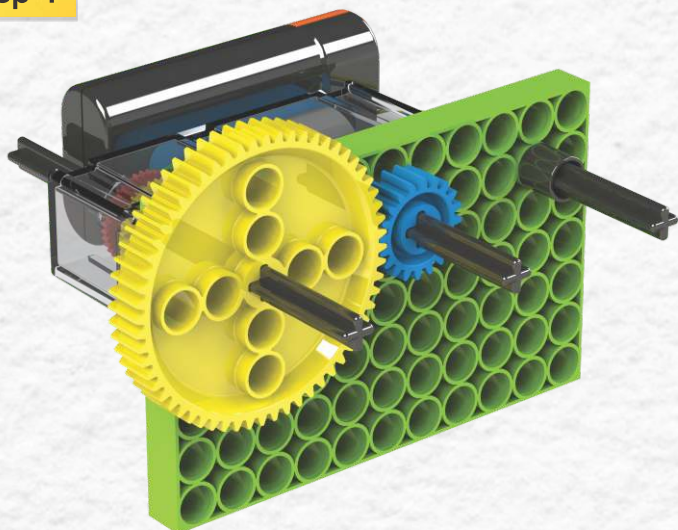

G(60) 1 pc.



G(20) 1 pc.



TW1 1 pc.

# Blix

## Step 5



G(60) 1 pc.



G(20) 1 pc.

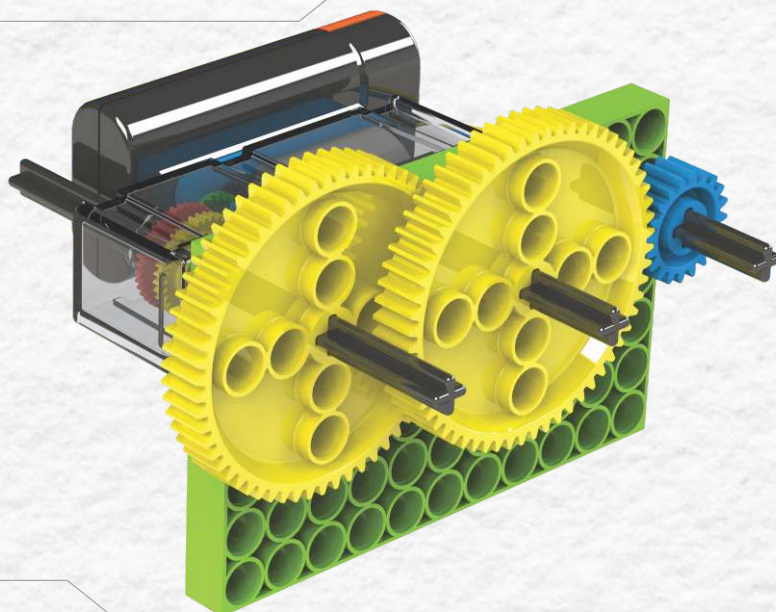

## Step 6

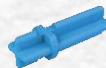
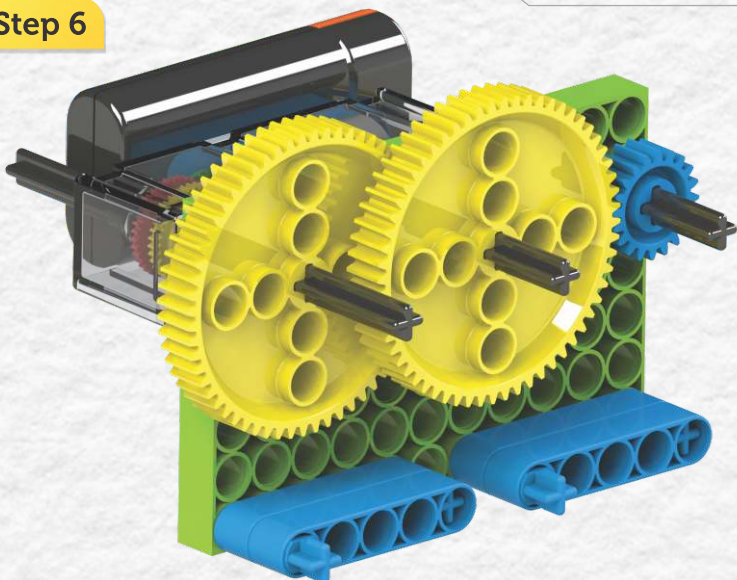

CT3 4 pcs.

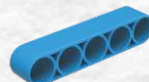

P5 4 pcs.

## Step 7



G(20) Idler 1 pc.



G(20) 1 pc.



CL2 1 pc.

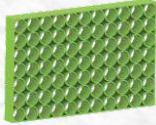

P7X11 1 pc.

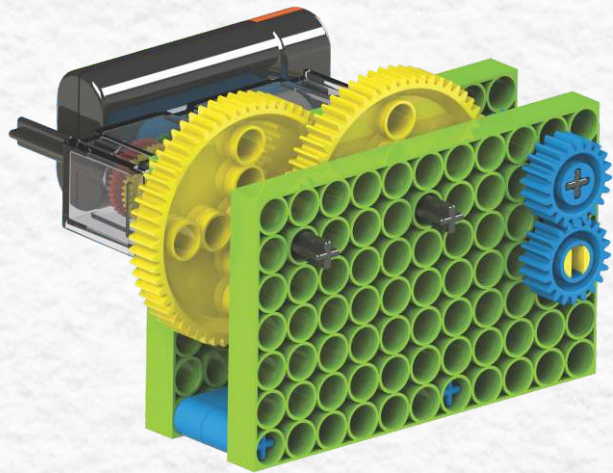

## Step 8

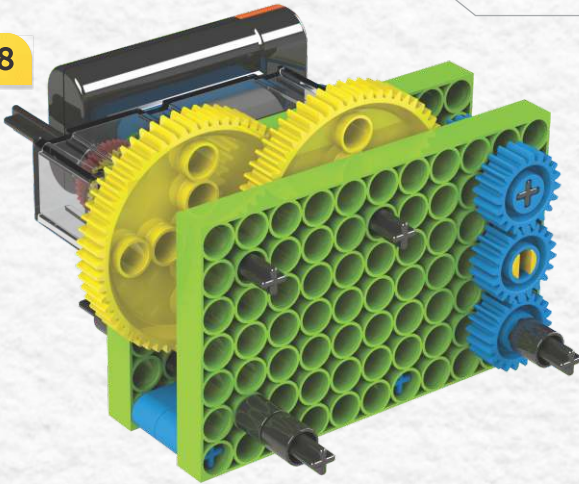

SH100 2 pcs.



G(20) 1 pc.



TW1 7 pcs.

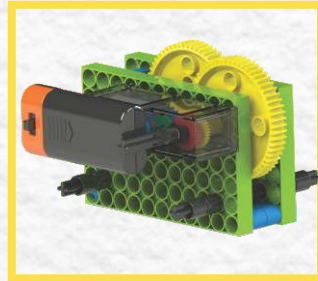

## Step 9

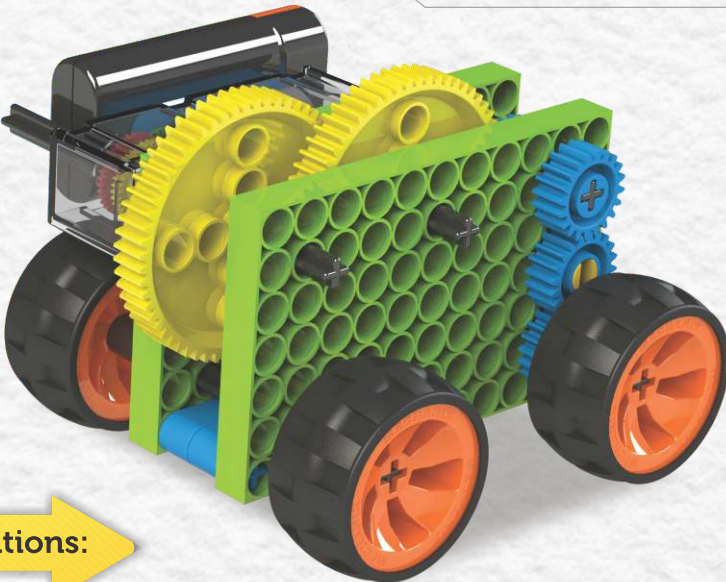

Wheels 4 pcs.



## Observations:

- The calculations are same as in the previous experiment but here the power is reduced by 9 times while the speed is increased by 9 times.
- Therefore, if the motor is running at 60 R.P.M, the wheels are now rotating at  $60 \times 9 = 540$  R.P.M.!

## Experiment 9: 4-Wheel-Drive car!

# Blix

In this experiment, we will make a car where all 4 wheels are powered by the single motor using gears. Usually off road vehicles use a 4 wheel drive system to drive over rough terrain without getting stuck.

Follow the steps and complete the model for experiment 9.

### Step 1

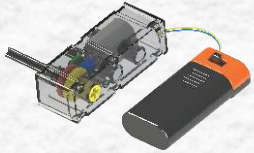

Motor with  
Battery Box



CT2 2 pcs.



SH60 1 pc.

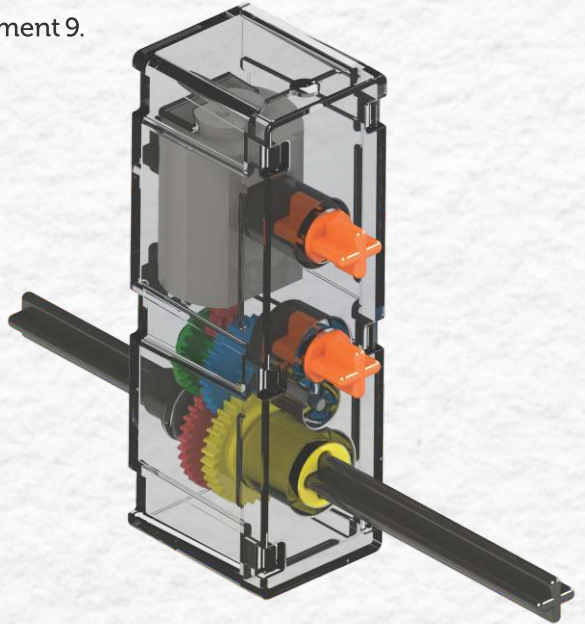

### Step 2

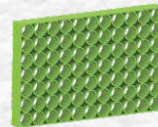
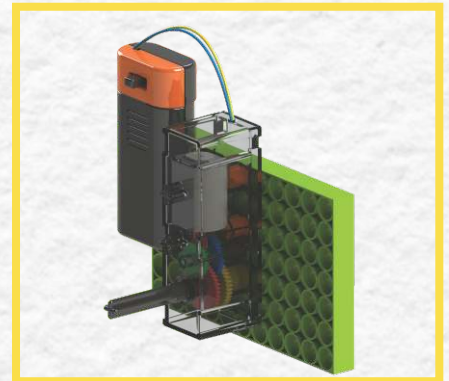
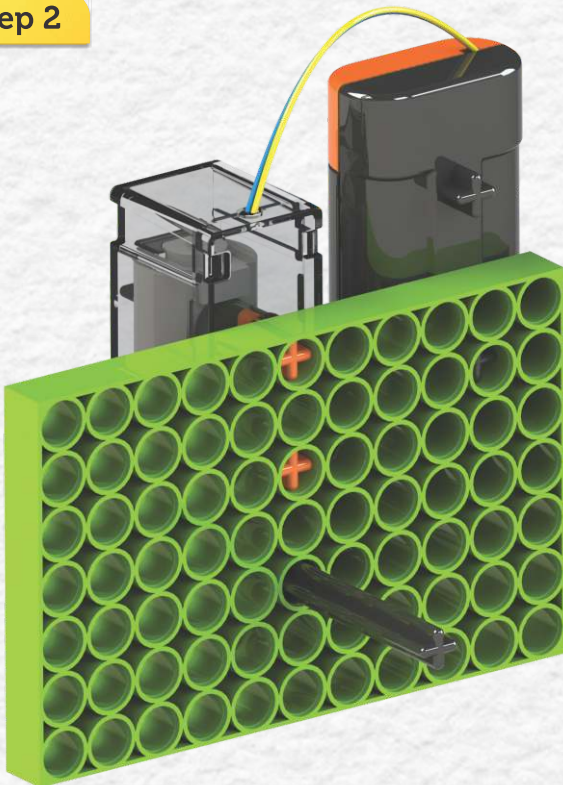

P7X11 1 pc.

### Step 3

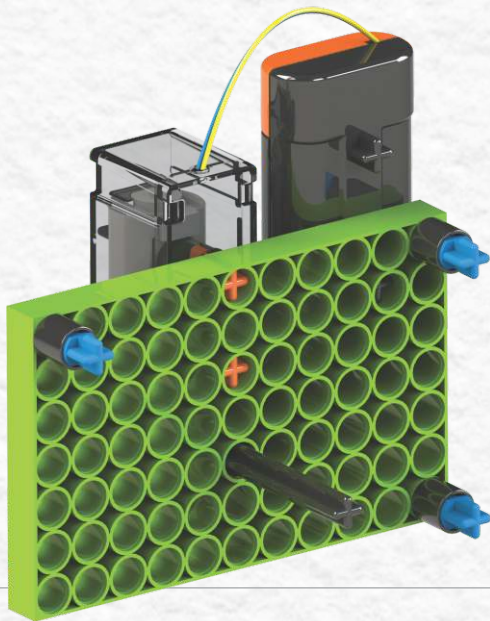

CT3 3 pcs.

TW1 3 pc.

### Step 4

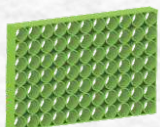

P7X11 1 pc.



G(60) 1 pc.

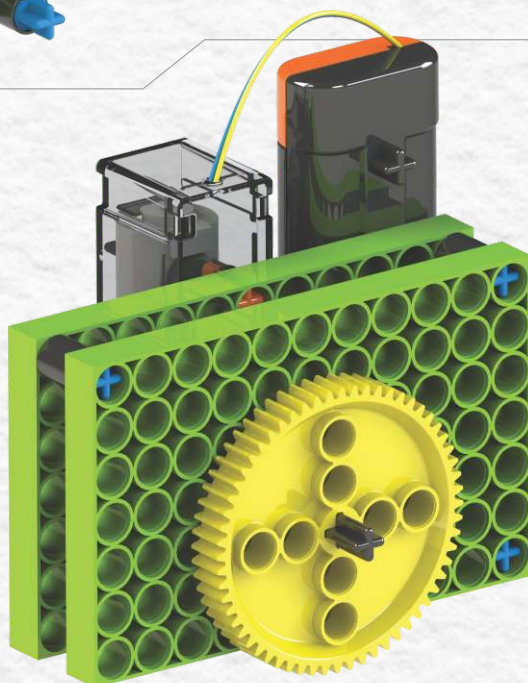

### Step 5

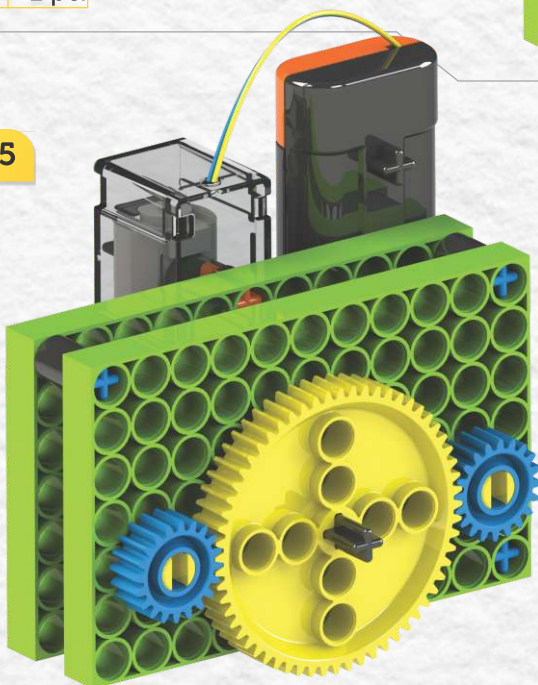

CL2 2 pcs.

G(20) Idler 2 pcs.

## Step 6



SH100 2 pcs.



TW1 6 pcs.



G(20) 2 pcs.

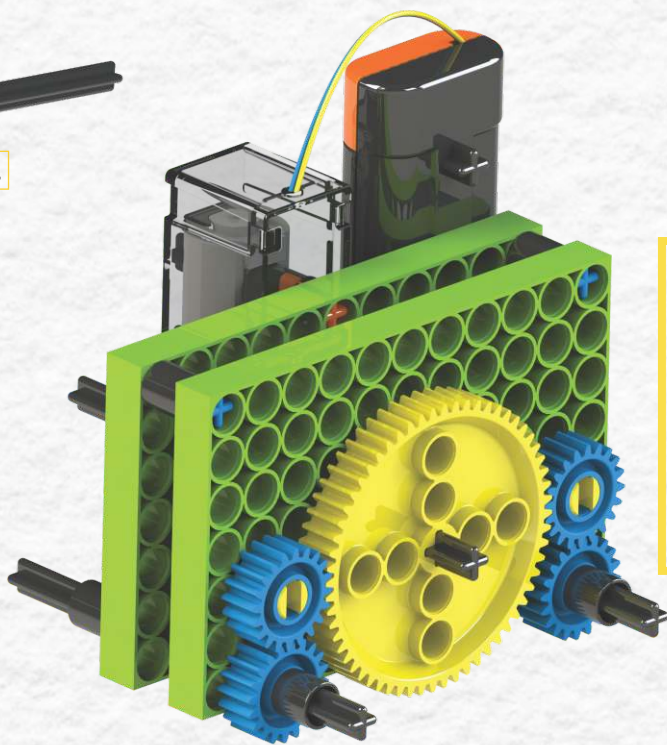

## Step 7



Wheels 4 pcs.

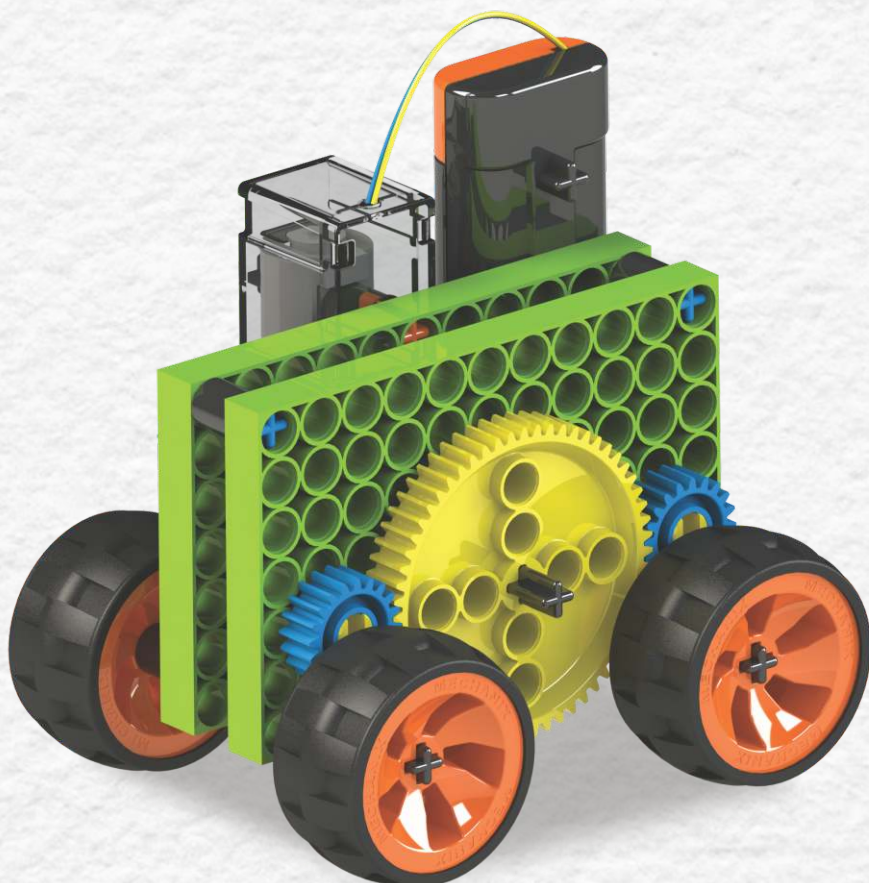

# Blix

## Experiment 10: Car with a real working gear box (R-N-1-2).

All that we have learnt in the previous 9 experiments, we shall use now to create a car in which you can actually change gears! You can shift from Reverse – Neutral – 1<sup>st</sup> – 2<sup>nd</sup>.

Follow the instructions and build the model for experiment 10.

### Step 1

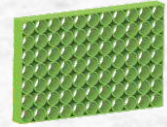
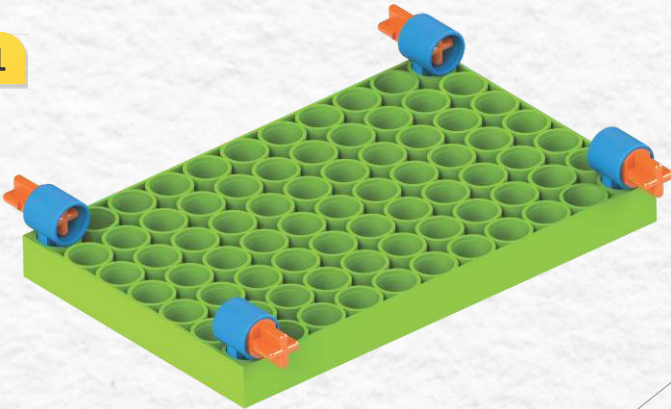

P7X11 1 pc.



CT2 4 pcs.



CH2 4 pcs.

### Step 2

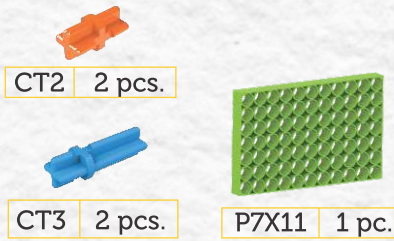

CT2 2 pcs.

CT3 2 pcs.

P7X11 1 pc.

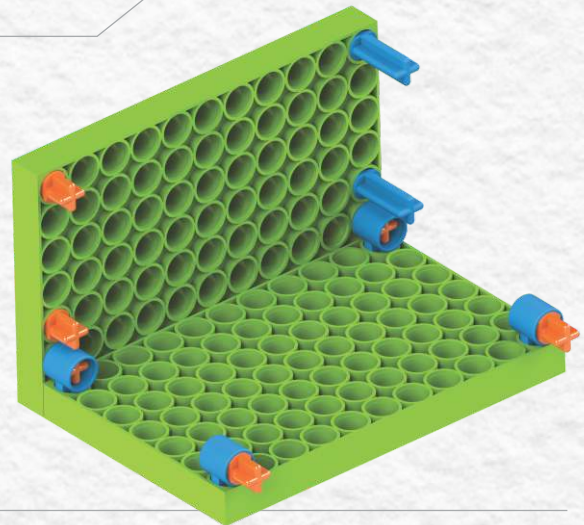

### Step 3

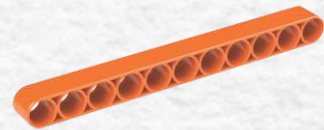
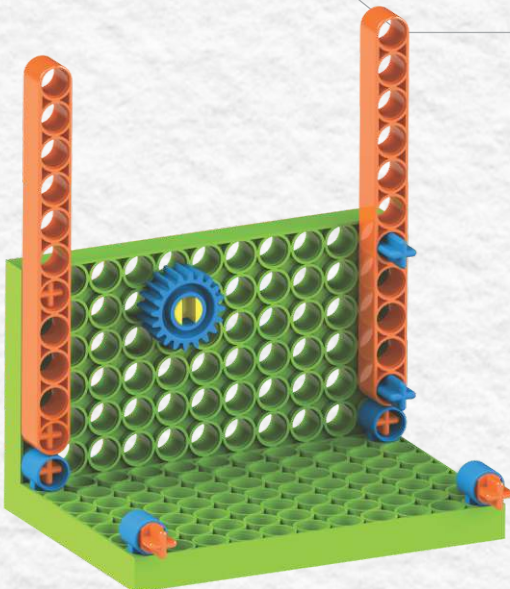

P11 2 pcs.



CL2 1 pc.



G(20) Idler 1 pc.

## Step 4

# Blix



Shaft Key 2 pcs.

G(60) 1 pc.

G(20) 2 pcs.

SH170 1 pc.

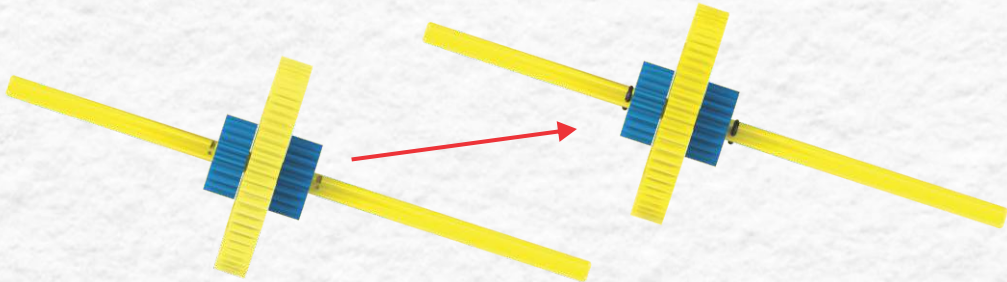

## Step 5

Assembly Step 4 and Step 3

Shorter Side

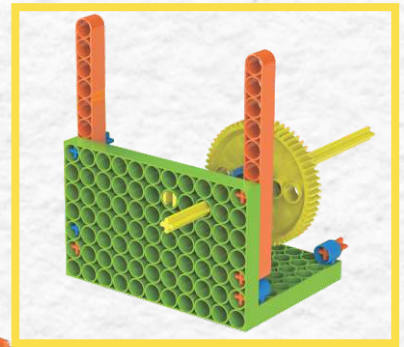
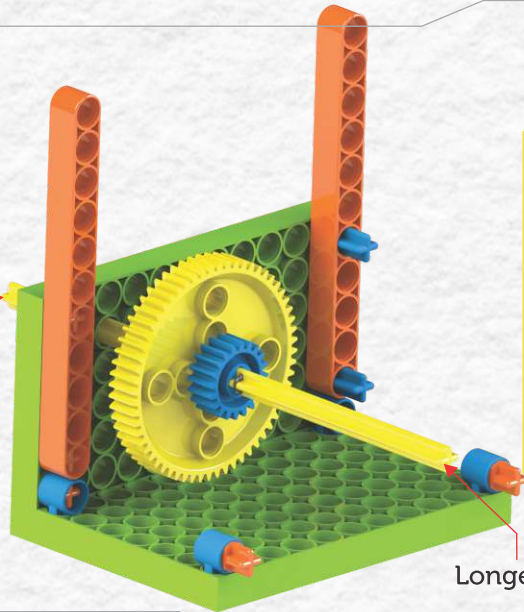

Longer Side

## Step 6

SH100 1 pc.

G(20) 2 pcs.

TW1 4 pcs.

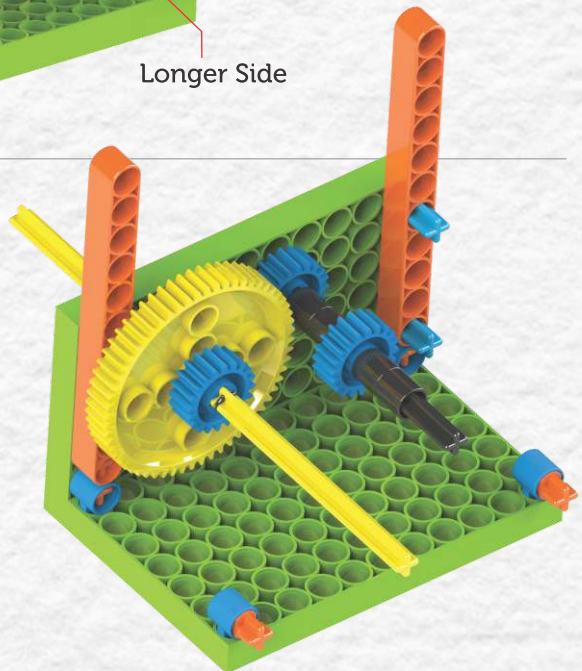



### Step 7

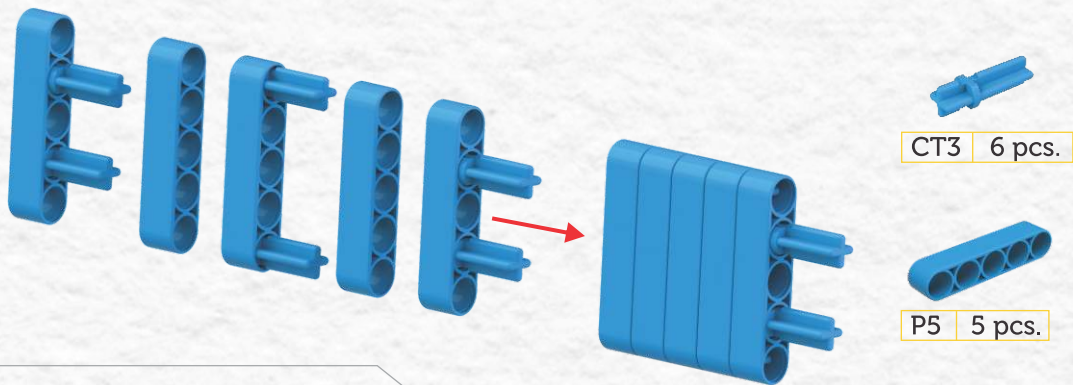

### Step 8

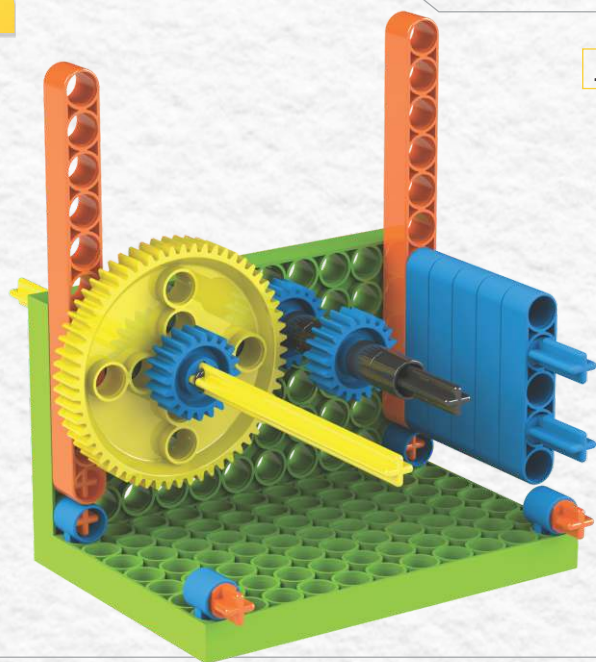





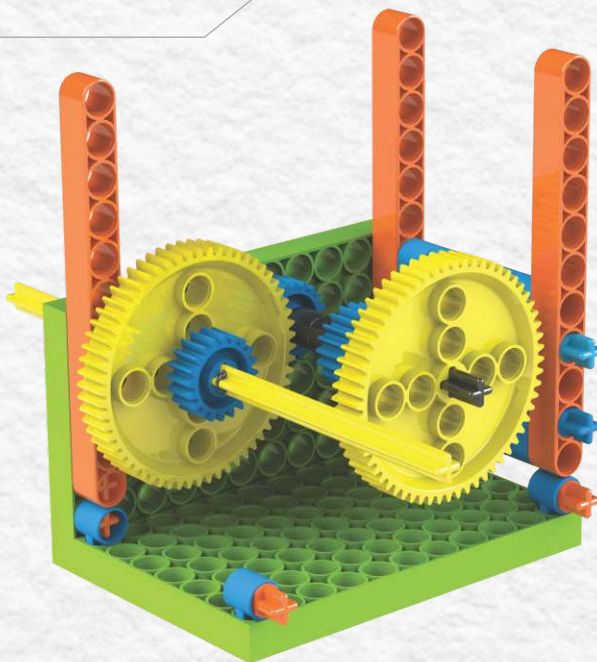
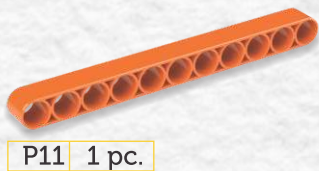
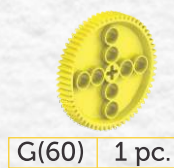

Assembly Step 7 and Step 6

### Step 9

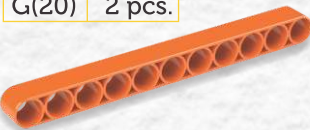

## Step 10

-  CT2 4 pcs.
-  CL2 1 pc.
-  G(20) Idler 1 pc.
-  G(20) 2 pcs.
-  P11 1 pc.
-  SH170 2 pcs.

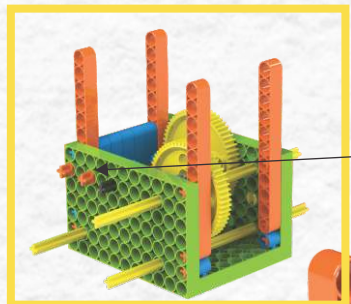



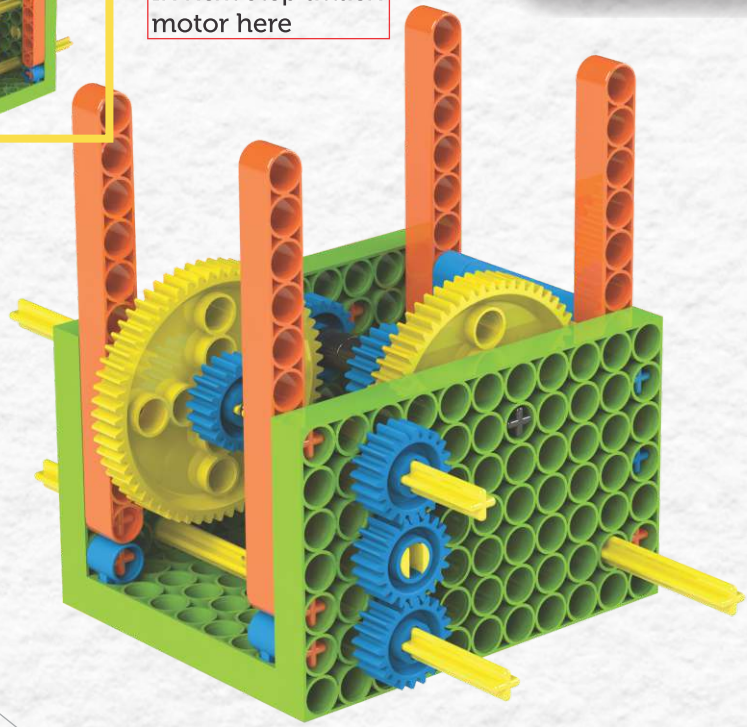

In next step attach motor here

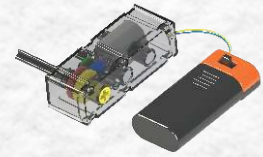
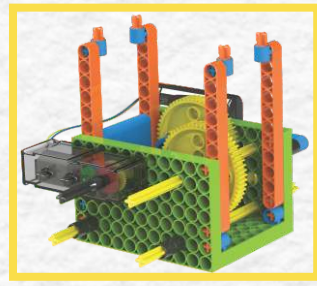
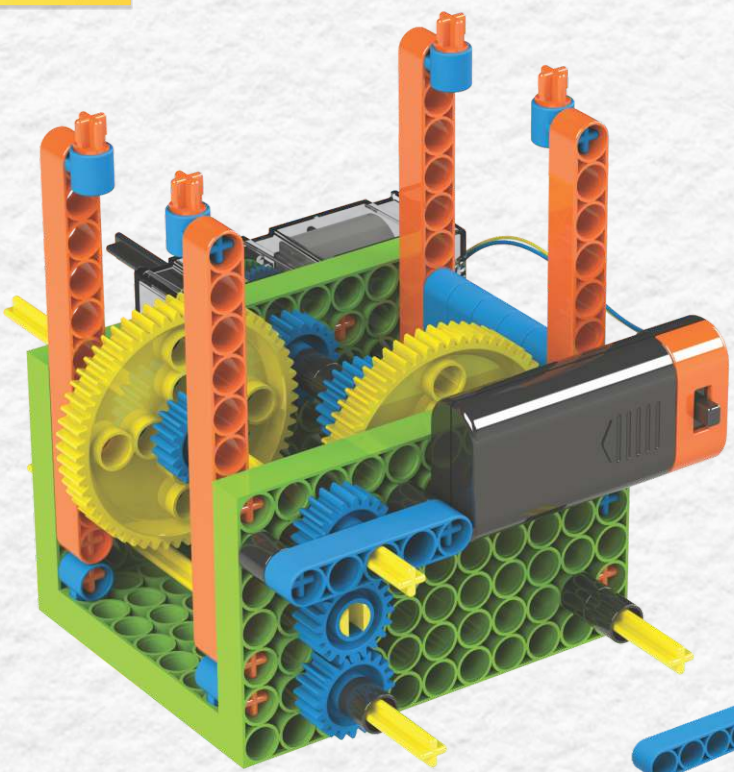

## Step 11

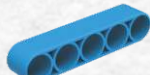

Motor with battery Box 1 pc.

-  TW1 9 pcs.
-  CH2 4 pcs.
-  P5 1 pc.
-  CT2 4 pcs.
-  CT3 2 pcs.

## Step 12

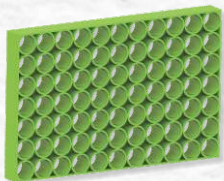

P7X11 1 pc.

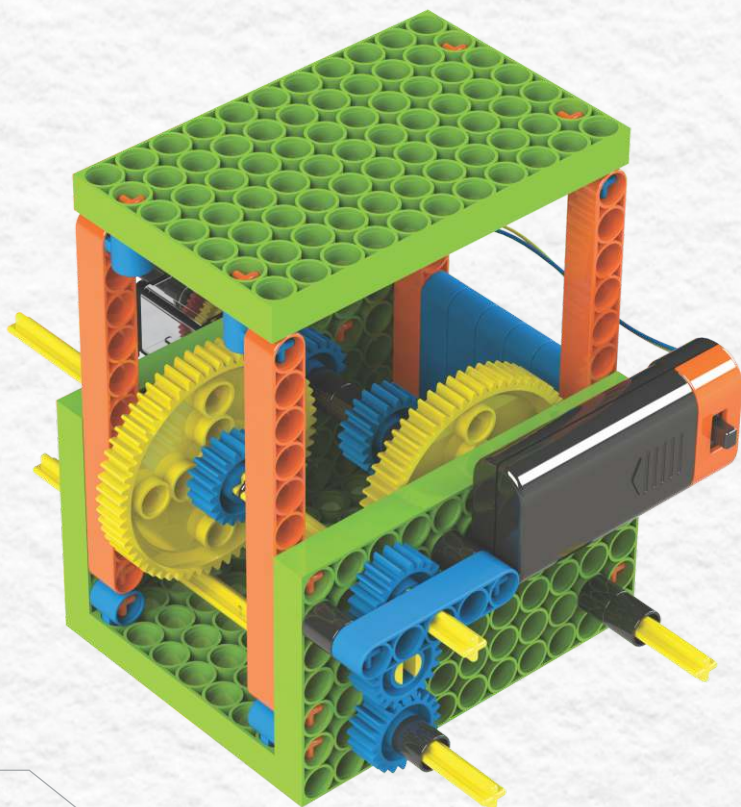

## Step 13

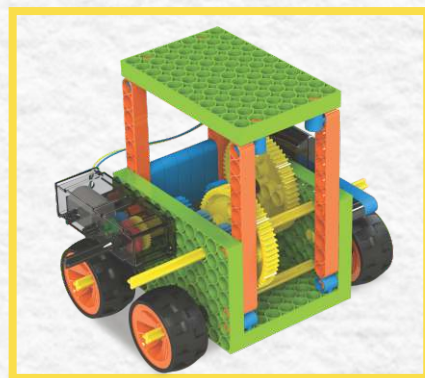
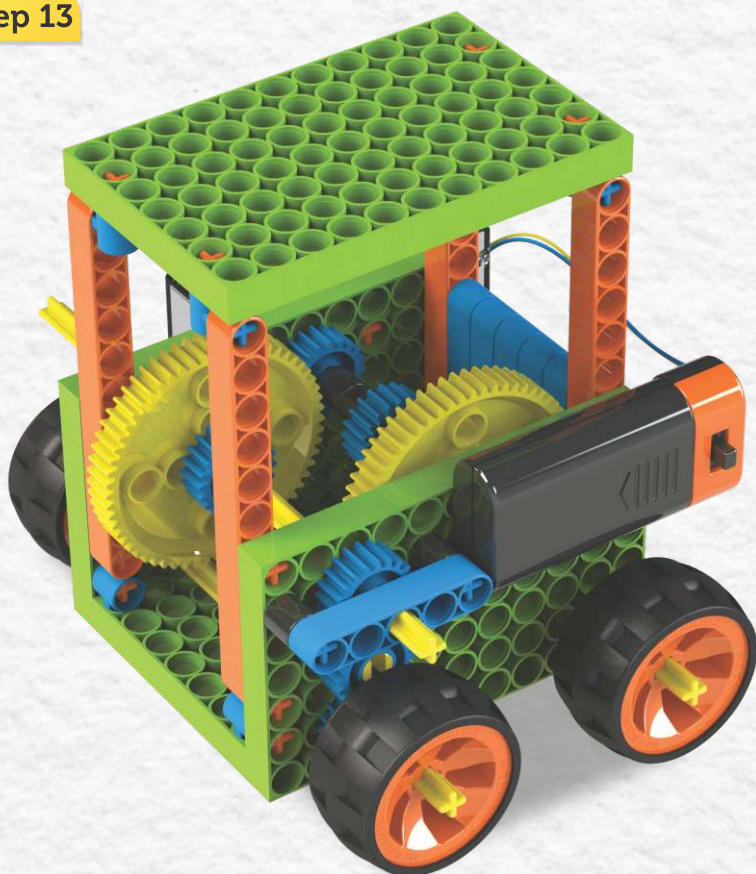

Wheels 4 pcs.

## Function:

- The yellow shaft is your gear shifter (similar to what you see in a car).
- Reverse - Slide it all the way into the corner for reverse. (Idler gear changes the direction).
- Neutral – This is where the motor is running but the vehicle does not move. Sliding the shaft outward shift the car in neutral.
- 1<sup>st</sup> Gear – In this gear, the car will move slowly but it have higher torque. Slide the shaft further outwards.
- 2<sup>nd</sup> Gear – In our car, this is the top gear. Slide the shaft in the furthest position. The speed in this gear is high but the pickup is slow and torque is low.

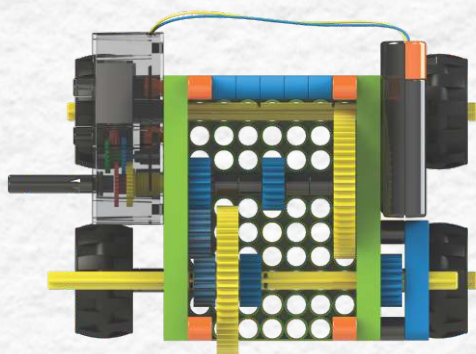

Reverse Gear

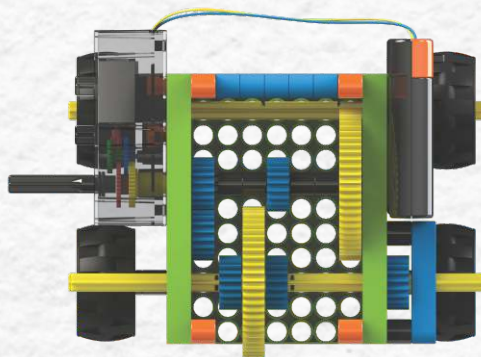

Neutral Gear

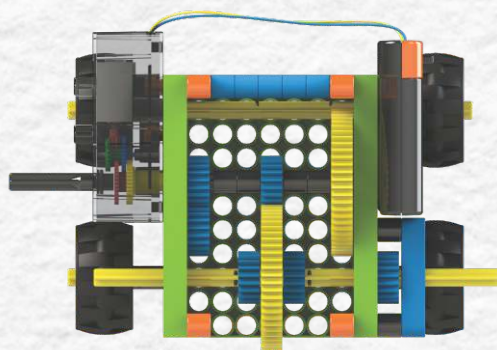

1<sup>st</sup> Gear

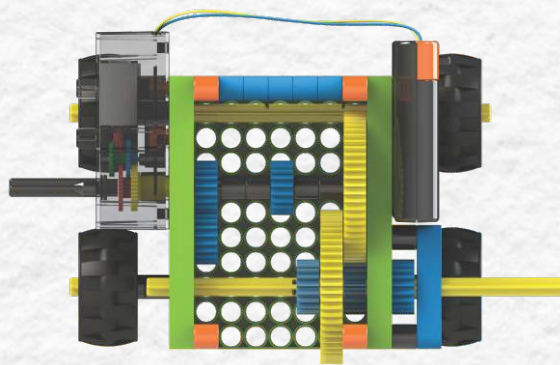

2<sup>nd</sup> Gear

## Fun experiment:

1. Put the car in 2<sup>nd</sup> gear and place weights on the roof. Keep adding more weight and see how much the car can carry before it stops.
2. Now try and do the same but after shifting it into 1<sup>st</sup> gear. Can it carry more? And how much more?

# Check out our other Blix Sets



## Blix CARS-1



## Blix CARS-2





Also From

**ZEPHYR**

More Than Just Play

MECHANIX - Robotix - 3



MECHANIX - Battle Station - Transporter



MECHANIX - Eiffel Tower



**MECHANIX**

# Blix

## GEAR BOX

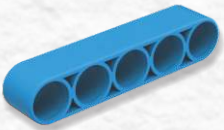

P5 6 pcs.

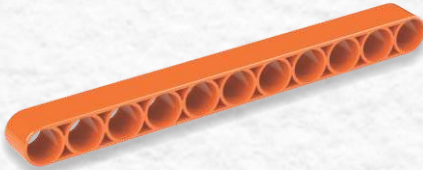

P11 4 pcs.



CT2 18 pcs.

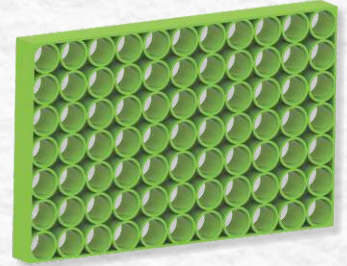

P7X11 4 pcs.

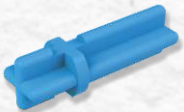

CT3 14 pcs.

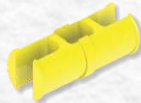

CL2 4 pcs.



CH2 10 pcs.



TW1 15 pcs.



G(60) 2 pcs.



G(20) 6 pcs.



G(20) Idler 2 pcs.



Wheels 4 pcs.



SH60 3 pcs.



SH100 2 pcs.



SH170 3 pcs.



Shaft Key 4 pcs.

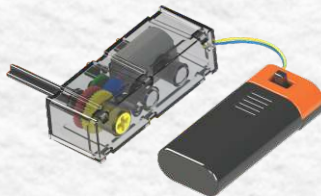

Motor With Battery  
Box 1pc.



Remover Tool 1 pc.